

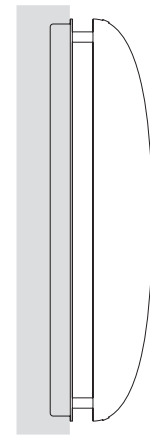

## Radius Avalon Wall Scone

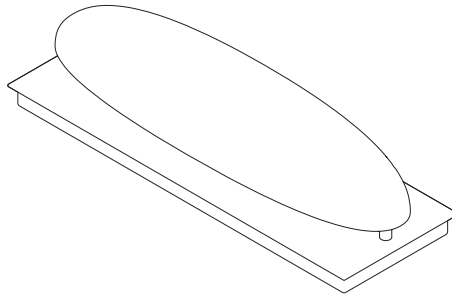

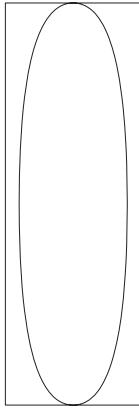



Projection

**Size** Length: 40 cm / 15.7" – Width: 13,5 cm / 5.3" – Projection: 10 cm / 4"

<b>Fixture type</b>	Wall Scone
<b>Illuminant</b>	LED strip light. CRI>90
<b>Lights</b>	440 LM
<b>Consumption</b>	6 Watts
<b>Materials</b>	Aluminum, steel and polycarbonate.
<b>Finish</b>	Powder coated and wet spray enamel
<b>Weight</b>	1,4 kg / 3.1 lbs.
<b>Packaging</b>	15 x 15 x 42 cm, 1,6 kg / 5.9 x 5.9 x 16.5", 35 lbs.

Lamping options	Color temp.	Controller	Driver/Description
Standard (ST)	2700K/3500K	T.B.D.	Built-in driver with TRIAC dimming/Lutron

Standard Colors	Jet Black RAL 9005	Traffic White RAL 9016	Signal Gray RAL 7004	Vermilion RAL 2002	Light Green RAL 6027
					

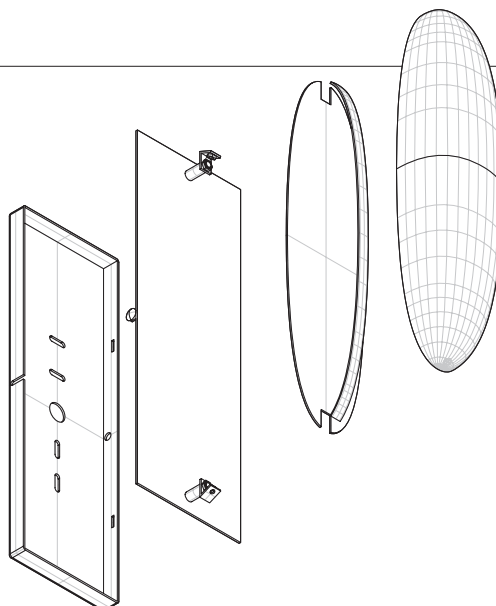

2016 OCTOBER

**esko design**

Ny Esbjergvej 12 . 4720 Præstø, Denmark . +45 70 22 92 90 . sales@eskodesign.com . www.eskodesign.com  
© All rights reserved